

Article number: 203502702683ST

Description: E+G Levelling sets GN 350.2-70-26-83-ST

Measures

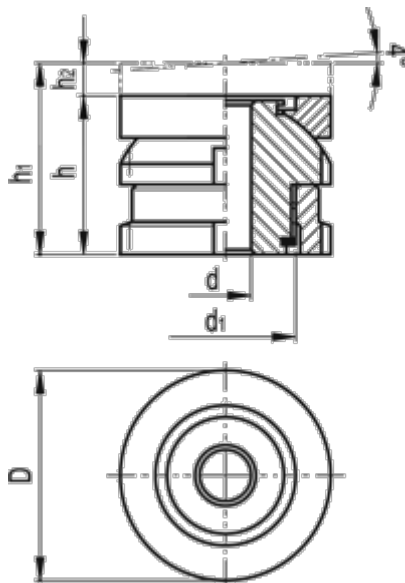

C-spanner DIN 1810 = A68-75

d = 26

D = 70

d1 = M50x1.5

For screw = M24

h = 83

h1 = 123

h2 = 40

Max static load (kN) = 225

Static preload (kN) = 97.3

Weight (g) = 1823